

SERVICE MANUAL

MODEL : MPC500 (AKAI)



Specification

■ General

Display:	2 x 16 charatec LCD w/back light
Memory card slot:	Compact Flash (The size of the compact flash card that MPC500 can handle if from 32MB to 2 GB)
Dimensions:	266mm x 175mm x 44mm
Weight:	1.34kg
Power requiremntn:	12v DC 600mA (negative tip)
Battery life:	Approximately 4.5 hour of continuous use with LCD backlight

■ Sound Generator

Sampling rate:	44.1kHz
Memory capacity:	16MB standard (11.5MB for sound memory), expandable to 128MB
Recording time:	136sec. (16MB, MONO) ; 24M28sec. (128MB,MONO)
Memory expansion slot:	1 x for optional EXM128
Data format:	16-bit linear
Polyphony:	up to 32 (dependent on processing)
Dynamic filtering:	2-pole lowpass filter per voice
Preset sound memory:	5MB
Number of programs:	24

■ Effects

Effects:	2 stereo effects and Master effect
Effect type:	Chorus, Flanger, Bit grunger, 4 band EQ, Compressor, phase shifter, Tremolo, Flying pan, Reverb, Delay
Master effect:	4 band EQ, Compressor

■ Sequencer

Maximum events:	100,000 notes
Resolution:	96 parts per 1/4-note
Sequences:	99
Tracks per sequence:	48
MIDI output channels:	16
Song mode:	20 songs, 250 steps per song
Drum pad:	12 (velocity and pressure sensitive)
Drum pad banks:	4
Sync mode:	MIDI clock

■ Inputs/Outputs

Record input (L and R):	1/4-inch stereo phone x 2, pseudo balanced + 11dBu, input impedance 9k ohm
Max. Input level:	+10dBu
Stereo output (L and R):	1/4-inch phone x 2 pseudo balanced + 11dBu, output impedance 1k Ohms,
Max. Output level:	+5 dBu
Phones output:	1/4-inch stereo phone x 1, 200mW / 100 ohms
MIDI inputs:	1 x 5-pin DIN
MIDI outputs:	1 x 5-pin DIN
USB:	Slave connector x 1, USB MASS STORAGE CLASS support (Windows 2000/ME/XP or later version, or Mac OS 9.x/10.x or later version)

■ Data Compatibility

MPC1000:	SEQ, WAV, PGM
MPC2000/2000XL:	SEQ, WAV, SND, PGM (Most parameters of PGM file can be loaded)
MPC2500:	SEQ, WAV, PGM
MPC4000:	SEQ, WAV, PGM (DRUM program only. Only note assign and tune are loaded)
MPC3000:	SND (THRU Computer)
Z4/Z8:	WAV, PGM (DRUM program only. Only note assign and tune are loaded)
S5000/6000:	WAV only (THRU Computer)

DISASSEMBLY PROCEDURES

1. REMOVAL OF METAL TOP COVER/BOTTOM COVER (Fig. 1)

- (a) Take off knob slide from the top panel.
- (b) Unscrew and remove 6 pcs of screw from the bottom cover.

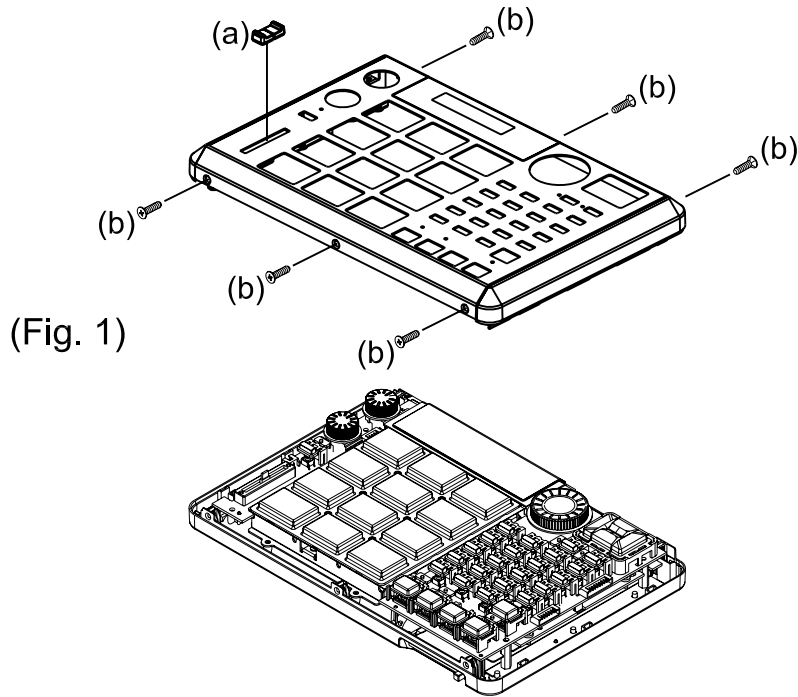

2. REMOVAL OF SW PCB ASS'Y/BOTTOM COVER (Fig. 2)

- (a) Remove knob jog and cursor button from PCB.
- (b) Unscrew and remove 5 pcs of screw from bottom cover.

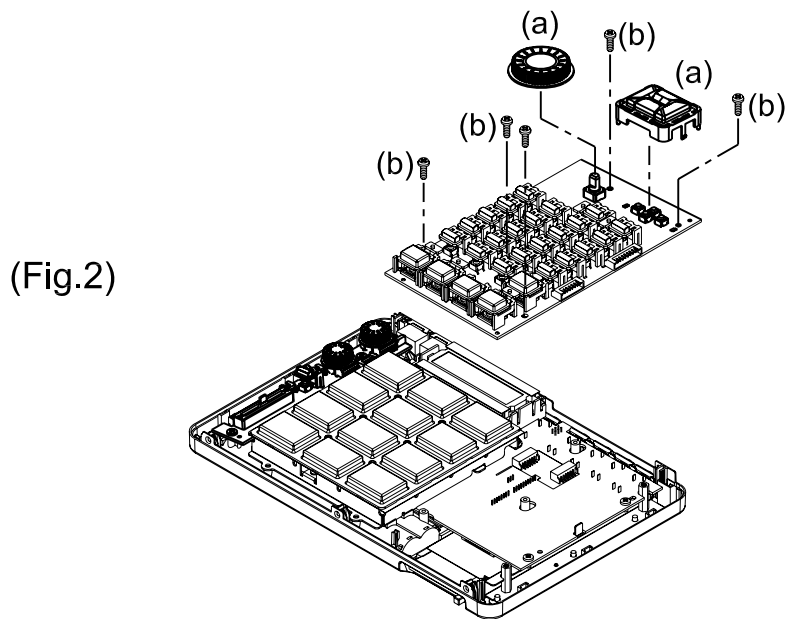

DISASSEMBLY PROCEDURES

3. REMOVAL OF POT PCB ASS'Y AND HOLDER PAD (Fig. 3)

(a) Unscrew and remove 5 pcs of screw from bottom cover.

(Fig. 3)

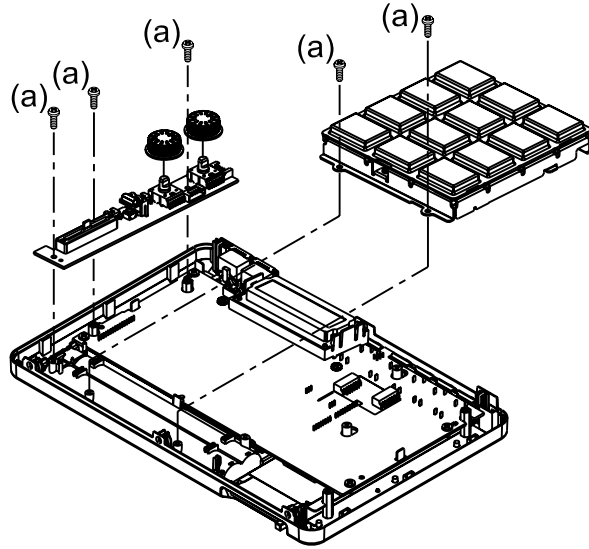

MPC500 PACKING DRAWING

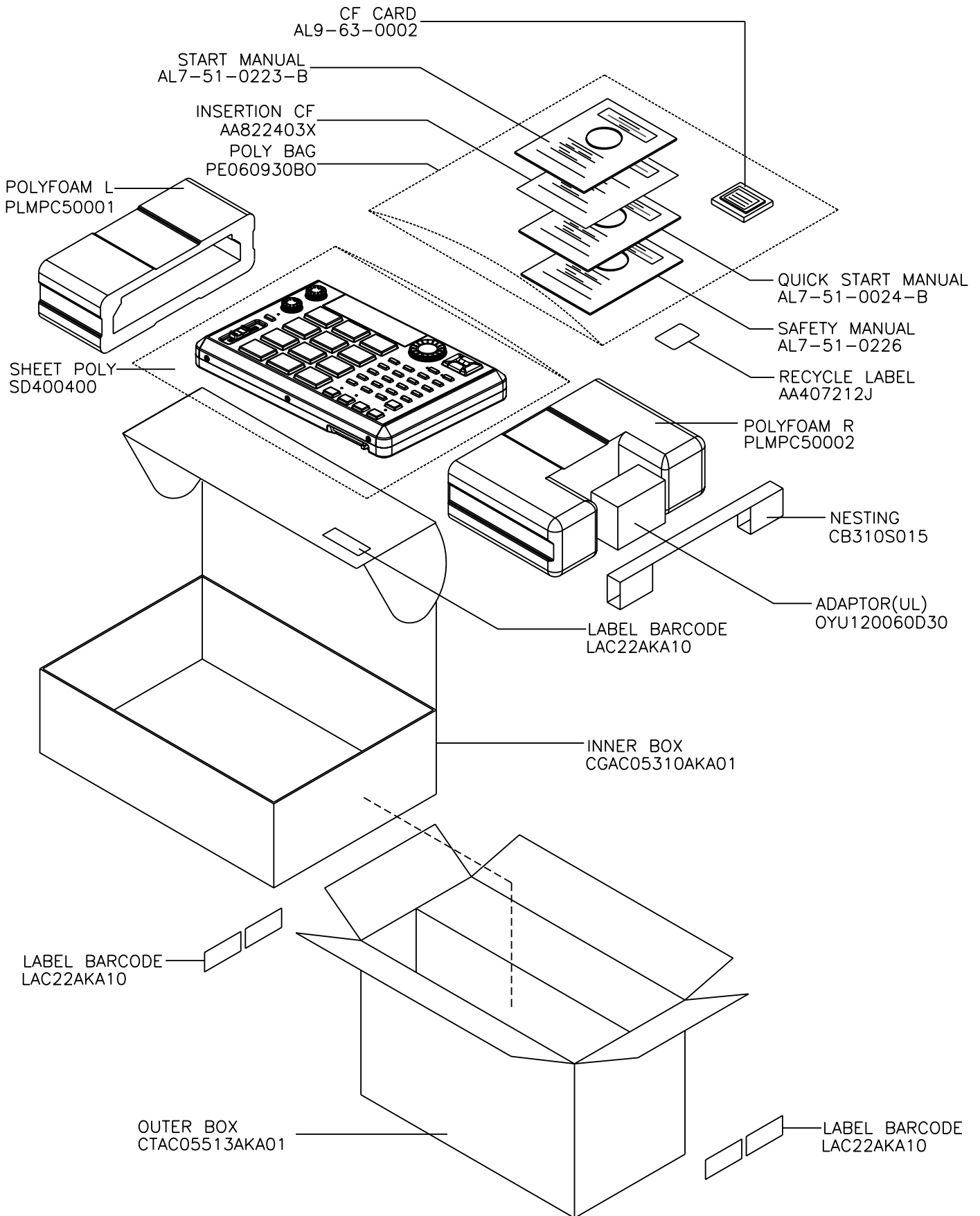

1 CARTON = 2 UNIT

EXPLODE VIEW
MODEL: MPC500AKA01~05

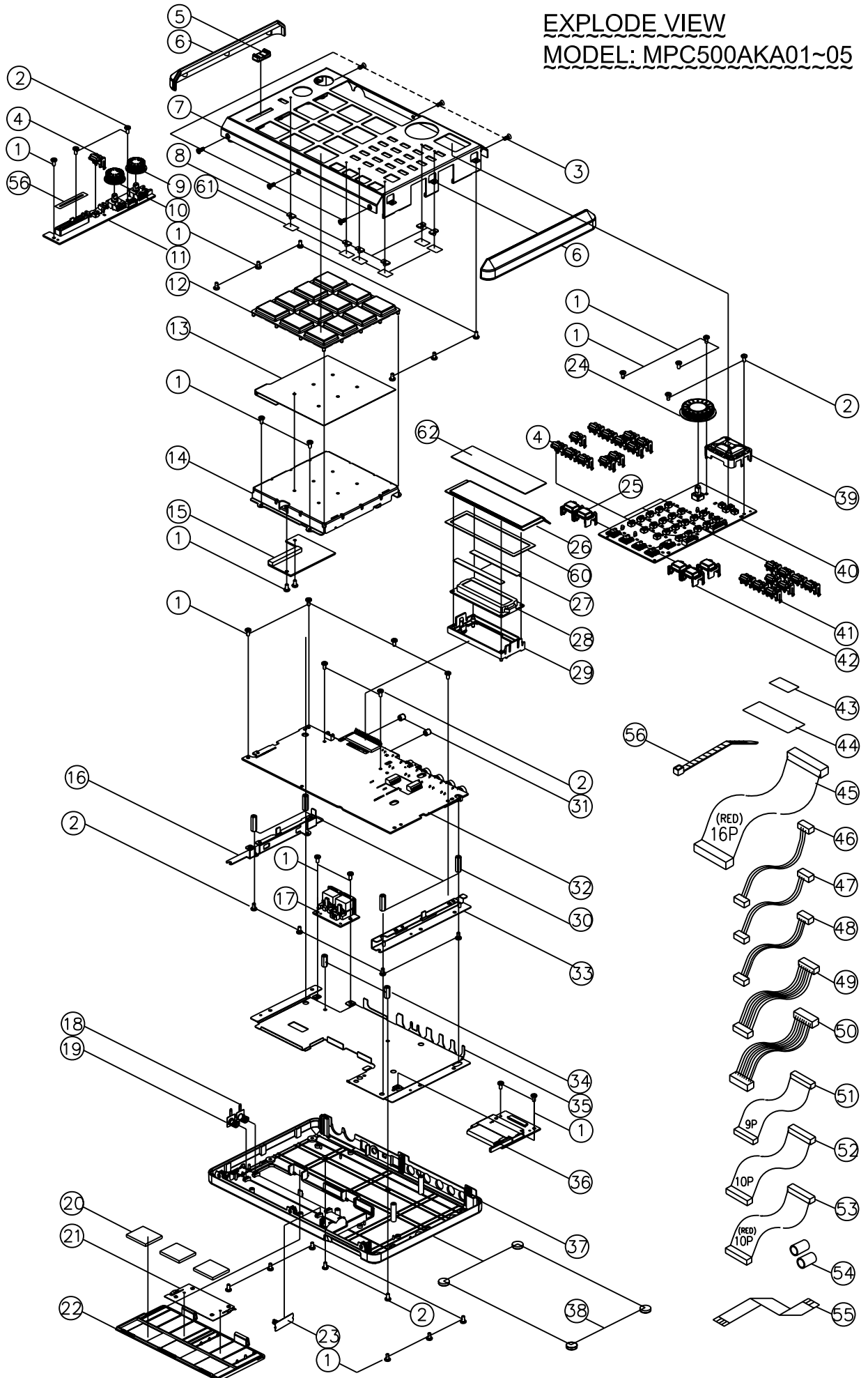

P:\MECHA\IP.SPEC\MPC500\EXPLODE--MPC500

MPC500 (AKAI) BOM

LEVEL	PART NUMBER	DESCRIPTION	QTY	REF
.1	AA406633J	PE BAG 370X280X.03 PRINTING	0.006	
.1	AA407212J	LABEL RECYCLE PE04	1.000	
.1	AA810353J	LENS LED	6.000	8
.1	AA811571J	CAUTION LABEL	1.000	44
.1	AA821339X	SHEET POLY 0450X0450	1.000	
.1	AA821858X	EVA	1.000	56
.1	AA822124X	LABEL FCC-S	1.000	43
.1	AA822330X	BUTTON PUSH (B)-7	13.000	4
.1	AA822331X	BUTTON PUSH (B)-8	9.000	41
.1	AA822367X	42P FLAT WIRE 60MM	1.000	55
.1	AA822403X	INSERTION CF MPC	1.000	
.1	AL7-40-0052	ADAPTOR 12VDC 600MA MPC500-UL	1.000	
.1	AL7-51-0223-B	START MANUAL (MPC500)	1.000	
.1	AL7-51-0224-B	QUICK START MANUAL (MPC500)	1.000	
.1	AL7-51-0226	SAFETY INSTRUCTION	1.000	
.1	AL9-63-0002	CF CARD 128MB	1.000	
.1	BA71028-130	BATTERY TERMINAL 71028-130	1.000	18
.1	BA71209-130	BATTERY TERMINAL 71029-130	1.000	19
.1	BA71228-130	BATTERY TERMINAL 71228-130	1.000	23
.1	BAAR-291	FOOT	4.000	38
.1	BAS-MS-RR3NNS	PAD SENSOR	1.000	13
.1	CB310S015	NESTING	1.000	
.1	CGAC05310AKA01	INNER CARTON (CARTON CASE MPC50)	1.000	
.1	CN0320002005	3P CONNECTOR WIRE 200MM (L4040 W901)	1.000	46
.1	CN0320002303	3P CONNECTOR WIRE 230MM (L4040 W303)	1.000	47
.1	CN0420000502	4P CONNECTOR WIRE 50MM (L4040 W107)	1.000	48
.1	CN0720001101	7P CONNECTOR WIRE 110MM (L4040 J4B)	1.000	49
.1	CN0720001201	7P CONNECTOR WIRE 120MM (L4040 J4A)	1.000	50
.1	CN0920000901	9P CONNECTOR WIRE 90MM (L4040 W302)	1.000	51
.1	CN1020001002	10P CONNECTOR WIRE 100MM (L4040 W301)	1.000	52
.1	CN1020001102	10P CONNECTOR WIRE 110MM (L4040 J106)	1.000	53
.1	CTAC05513AKA01	OUTER CARTON (CARTON MASTER MPC)	0.500	
.1	EVA1504401	SHIELD LCD EVA01	2.000	27
.1	EVA1504402	BATTERY CUSHION	3.000	20
.1	HST030012BUL	HEAT SHRINKABLE TUBE 3X12MM	2.000	54
.1	K46-1	CABLE TIE	1.000	59
.1	LAC22AKA11	LABEL BARCODE-B MPC500(A)	1.000	
.1	LAC67YAH261	LABEL (GREEN MARKING)	1.000	
.1	LAM67AKA01	DOUBLE SIDE TAPE (SEKON) 45MM X 122MM	1.000	60
.1	LAM67AKA02	DOUBLE SIDE TAPE (SEKON) 10MM X 3MM	6.000	61
.1	LAM67AKA03	PROTECTION TAPE (SEKON) (ID-S040) 111.5MM X 37.5MM	1.000	62
.1	LAM67AKA04	LABEL STICKER FOR CF CARD	1.000	
.1	MT1504308	COPPER L=18.2	4.000	30
.1	MT1504309	COPPER L=13	2.000	34
.1	MT1504310	ANGLE PCB L	1.000	16
.1	MT1504311	ANGLE PCB R	1.000	33
.1	MT1504406	HOLDER PAD	1.000	14
.1	MT1512201	SHIELD MEMORY	1.000	21
.1	MT1512202	SHIELD PCB	1.000	35
.1	MT153000301	METAL TOP MPC500	1.000	7
..2	MT1530003	METAL TOP MPC500 (R)	1.000	
.1	PLMPC50001	POLY FOAM-L	1.000	
.1	PLMPC50002	POLY FOAM-R	1.000	
.1	PT150140301	LENS TOP	1.000	26
..2	PT1501403	LENS TOP (R)	1.000	
.1	PT1504304	HOLDER LCD	1.000	29
.1	PT151060301	BUTTON CURSOR (AA822307X)	1.000	39
..2	PT1510603	BUTTON CURSOR (AA822307X)	1.000	
.1	PT151060801	KNOB JOG	1.000	24

LEVEL	PART NUMBER	DESCRIPTION	QTY	REF
..2	PT1510608	KNOB JOG (R)	1.000	
.1	PT151060901	KNOB VOLUME (A) ADD RED	1.000	9
..2	PT1510609	KNOB VOLUME (A) (R)	1.000	
.1	PT151060902	KNOB VOLUME (B) ADD WHITE	1.000	10
..2	PT1510609	KNOB VOLUME (A) (R)	1.000	
.1	PT151061101	KNOB SLIDE SMALL (ADD WHITE LINE)	1.000	5
..2	PT1510611	KNOB SLIDE SMALL	1.000	
.1	PT1510612	BUTTON TRANSPORT (A)	2.000	25
.1	PT1510613	BUTTON TRANSPORT (B)	3.000	42
.1	PT1510615	SWITCH BUTTON	2.000	31
.1	PT152060101	SIDE CAP (SPRAYING)	2.000	6
..2	PT1520601	SIDE CAP (R)	1.000	
.1	PT153010601	BATTERY DOOR (SPRAYING)	1.000	22
..2	PT1530106	BATTERY DOOR (R)	1.000	
.1	PT153030201	BOTTOM (SPRAYING)	1.000	37
..2	PT1530302	BOTTOM (R)	1.000	
.1	RU1504303	SILICON PAD	1.000	12
.1	SC0306PBB1	SCREW	22.000	1
.1	SC0306RIB1	SCREW (BLACK)	2.000	2
.1	SC0306RIN1	SCREW	10.000	58
.1	SC0308FBB1	SCREW	6.000	3
.1	SC0308PBB1	SCREW	6.000	57
.1	SD870530	LAMIN SHEET	1.000	
.1	TWAL9-44-0010	LCD ASS'Y	1.000	28
..2	BC1602CHBWAJB	IND LCD BC-1602C-HBWA-J-B	1.000	
..2	CN1620001501	16P CONNECTOR WIRE 150MM (L404 W105)	1.000	45
..2	TE522501601	16P CONNECTOR SOCKET 90°	1.000	
.1	TWPC06A00101	MAIN PCB ASS'Y (MPC500)	1.000	32
..2	EC10550TM	E. CAPACITOR 1UF/50V	2.000	C40,41
..2	EC10716TM	E. CAPACITOR 100UF/16V	3.000	C907,908,909
..2	EC22716TM	E. CAP 220UF/16V	5.000	C403,404,910,911,912
..2	EC47616TM	E. CAP 47UF/16V	2.000	C303,304
..2	AA428998J	D SILICON C.1SS355TE-17 T08E	1.000	D1
..2	AA812979J	IC HD74LVC245ATELL	3.000	IC5,6,7
..2	AA821781X	SOCKET DMM3-RS144A2B-13 144P	1.000	J3
..2	AA821788X	TR FET CHIP 2SK3065T100 T12E	4.000	TR1,2,3,4
..2	AA821789X	TR CHIP DTB113ZKT146 T08E	3.000	Q1,TR5,6
..2	AA821831X	IC DS1811R-10	1.000	IC13
..2	AA821836X	IC SI9706DY	1.000	IC8
..2	AA821874X	DETECTOR HCPL-0701	1.000	PH1
..2	AA822373X	SOCKET BL112-42RL 42P	1.000	J103
..2	AA822757X	TRANSISTOR 2SC3326	2.000	TR301,302
..2	AAHD6417727F	IC HD6417727F100CV QFTY	1.000	IC1
..2	AALM2674M	IC LM2674M-ADJ	3.000	IC901,902,903
..2	AL0-17-0330	RES CHIP ARRAY 4 X 33 OHM 1/16W 5% C-C=0.8MM	1.000	IB1
..2	AL0-20-1103	POT TRIM SMD 10KB SING-TURN RH03ADC14X	1.000	VR1
..2	AL2-51-0220	DIODE POWER SCHOTTKY B240-A 20V 2A SMA	5.000	D901,902,903,904
..2	AL2-51-4403	TRANSISTOR PNP 2N4403 40V 800MA SOT-23	1.000	TR901
..2	AL2-52-5228	DIODE ZENER MMBZ5230BLT1 SOT-23 SMD	1.000	D2
..2	AL2-61-0431	REG ADJ-SHUNT LM431 2.5V-37V 100mA 2% SOT-23	1.000	IC18
..2	AL2-64-2541	IC 74HCT541 OCTAL BUFFERS/DRIVERS W/TRI-STATE OUTS	1.000	IC9
..2	AL2-64-8032	IC 74AUP1G32 SINGLE 2-IN POS OR SOT23-5	1.000	IC12
..2	AL2-65-0014	IC 74LVC1G14 SINGLE INVERTER SOT-23	1.000	IC14
..2	AL2-71-0914	IC TS914 OP-AMP SOP-14	1.000	IC19
..2	AL2-71-2084	IC TLC084 4-OP AMP (SMD)	1.000	IC11
..2	AL2-75-0320	IC CODEC TLV320AIC23 STEREO TSSOP-28	1.000	IC101
..2	AL7-20-0077	INDUCTOR FERRITE BEAD 330 OHM @ 100MHZ 0805	4.000	FL1,2,3,4
..2	AL7-20-0078	INDUCTOR FERRITE BEAD 30 OHM @ 100MHZ 0805	11.000	FL5,6,7,8,9,10,11,12,13,14,15
..2	AL7-20-1039	INDUCTOR 39UH PE-53814SNL SMD LCI-30	3.000	L901,902,903
..2	CS103K5005X7R	C.CAP 0.010UF 50V X7R,±10% SMD 0805	8.000	C53,54,59,904,905,906,913,914

LEVEL	PART NUMBER	DESCRIPTION	QTY	REF
..2	CS104K5005X7R	CHIP CAP 0.1UF ±10% 50V 0805	47.000	C1,2,3,4,5,6,7,8,9,10,11,12,13,14,15,16,17, C18,20,21,22,23,24,25,26,27,28,29,30,31, C32,33,34,35,36,37,39,46,90,91,101,102, C103,104,888,915,916
..2	CS220J5005COG	C.CAP 22PF/50V/+5% (0805 SMD)	2.000	C61,62
..2	CS470J5005COG	CAPACITOR 47PF NPO 50V 0805	2.000	C201,202
..2	CS471J5005COG	CAPACITOR 470PF 5% NPO 50V 0805 (SMD)	2.000	C301,302
..2	CS471K5005X7R	CAP 470PF CER X7R 50V	2.000	C51,52
..2	CS472K5005X7R	CAPACITOR (SMD)	2.000	C401,402
..2	CS473K5005X7R	CAPACITOR (SMD) 47000PF	5.000	C56,58,901,902,903
..2	ICK4S641632E	IC (SDRAM) 64MB SDRAM	2.000	IC3,4
..2	ICSN74LVCC3245	IC 74LVCC3245 (ADWR)-DR39	1.000	IC10
..2	PC06A001	PCB BOARD (MAIN)	1.000	
..2	RS00018J05	CHIP RES. 0 OHM,1/8W,±5%,0805	1.000	R37
..2	RS10118J05	CHIP RES. 100 OHM,1/8W,±5%,0805	1.000	R3
..2	RS10218J05	CHIP RES. 1K OHM,1/8W,±5%,0805	4.000	R1,6,22,907
..2	RS10318J05	CHIP RES. 10K OHM,1/8W,±5%,0805	6.000	R16,28,42,307,308,913
..2	RS10418J05	CHIP RES. 100K OHM,1/8W,±5%,0805	6.000	R18,19,30,32,34,911
..2	RS15218J05	CHIP RES. 1.5K OHM,1/8W,±5%,0805	3.000	R11,17,23
..2	RS15318J05	CHIP RES. 15K OHM,1/8W,±5%,0805	1.000	R9
..2	RS16318J05	CHIP RES. 16K (0805) SMD	1.000	R4
..2	RS20118J05	CHIP RES. 200 OHM,1/8W,±5%,0805	2.000	R24,35
..2	RS22118J05	CHIP RES. 220 OHM,1/8W,±5%,0805	1.000	R2
..2	RS22218J05	CHIP RES. 2.2K OHM,1/8W,±5%,0805	1.000	R29
..2	RS22318J05	CHIP RES. 22K OHM,1/8W,±5%,0805	4.000	R305,306,403,404
..2	RS24118J05	CHIP RES. 240 OHM,1/8W,±5%,0805	3.000	R901,902,906
..2	RS24218J05	CHIP RES. 2.4K OHM,1/8W,±5%,0805	1.000	R909
..2	RS27018J05	CHIP RES. 27 OHM,1/8W,±5%,0805	3.000	R7,8,12
..2	RS30410J05	CHIP RES. 300K OHM,1/10W,±5%,0805	1.000	R31
..2	RS33018J05	CHIP RES. 33 OHM,1/8W,±5%,0805	6.000	R20,21,26,27,401,402
..2	RS33118J05	CHIP RES. 330 OHM,1/8W,±5%,0805	4.000	R43,44,301,302
..2	RS33218J05	CHIP RES. 3.3K OHM,1/8W,±5%,0805	2.000	R13,14
..2	RS33318J05	CHIP RES. 33K OHM,1/8W,±5%,0805	1.000	R10
..2	RS39318J05	CHIP RES. 39K OHM,1/8W,±5%,0805	1.000	R912
..2	RS43018J05	CHIP RESISTOR 43 OHM 1/8W, ±5%, 0805	2.000	R45,46
..2	RS43118J05	CHIP RES. 430 OHM,1/8W,±5%,0805	1.000	R905
..2	RS43318J05	CHIP RES. 43K OHM,1/8W,±5%,0805	2.000	R38,41
..2	RS47218J05	CHIP RES. 4.7K OHM,1/8W,±5%,0805	7.000	R25,33,36,39,40,201,202
..2	RS47318J05	CHIP RES. 47K OHM,1/8W,±5%,0805	1.000	R101
..2	RS51118J05	CHIP RES. 510 OHM,1/8W,±5%,0805	1.000	R903
..2	RS51218J05	CHIP RES. 5.1K OHM,1/8W,±5%,0805	1.000	R908
..2	RS51318J05	CHIP RES. 51K OHM,1/8W,±5%,0805	1.000	R15
..2	RS68118J05	CHIP RES. 680 OHM,1/8W,±5%,0805	2.000	R303,304
..2	RS75018J05	CHIP RES. 75 OHM,1/10W,±5%,0805	1.000	R910
..2	RS75118J05	CHIP RES. 750 OHM,1/8W,±5%,0805	1.000	R904
..2	RS82118J05	CHIP RES. 820 OHM,1/8W,±5%,0805	1.000	R5
..2	RS91218J05	CHIP RES. 9.1K OHM,1/8W,±5%,0805	2.000	R203,204
..2	TCS106M1006	TAN-CAP 10UF/10V (A CASE)SND A CASE	9.000	C70,71,72,73,74,75,105,108,175
..2	TWAA822384X	IC AM29LV641DL90REI	1.000	IC2
...3	AA822384X	IC S29GL064A90TFIR70 (PROGRAM BY PE)	1.000	
..2	XTM11289X	11.2896MHZ 5X7X1.75MM OSCILLATOR,FRE STAB 50PPM	1.000	X2
..2	XTM12000XSMD	OSCILLATOR 12.000MHZ 3.3V SMD	1.000	X1
..2	AA419246J	SOCKET 128A-050S2A-S14A 50P	1.000	J110
..2	AA820568X	20P IC SOCKET	1.000	(IC17)
..2	AA820569X	24P IC SOCKET	2.000	(IC15,16)
..2	AA821000X	PHONE J YKB26-5264 S.NUT 6.3	5.000	J201,202,301,302,401
..2	AL1-08-0222	E.CAP. 22UF 16V 20%(PANASONIC)	8.000	C19,38,42,43,48,49,203,204
..2	AL4-08-0402	CON USB SOCKET 4 PIN FEMALE PC-MNT HORIZONTAL	1.000	J2
..2	AL6-01-0012	SWITCH (OPEN/CLOSE) SSSF122NB1-YN2	1.000	SW2
..2	AL6-02-0059	SWITCH PUSH DPDT 2.5MM SPPJ32NE01	2.000	SW1,3
..2	AL9-61-0151	IC (PROGRAMMED AL2-33-0010)	1.000	IC15
...3	AL2-33-0010	IC GAL GAL20V8 24-PIN DIP (PROGRAM BY PE)	1.000	

LEVEL	PART NUMBER	DESCRIPTION	QTY	REF
..2	AL9-61-0152	IC (PROGRAMMED AL2-33-0010)	1.000	IC16
...3	AL2-33-0010	IC GAL GAL20V8 24-PIN DIP (PROGRAM BY PE)	1.000	
..2	AL9-61-0153	IC (PROGRAMMED AL2-33-0009)	1.000	IC17
...3	AL2-33-0009	IC GAL GAL16V8D-15QP 20-PIN DIP (PROGRAM BY PE)	1.000	
..2	JKDJ-0702B-025	DC SOCKET	1.000	J1
..2	TE10200702	7P CONNECTOR SOCKET	1.000	J4B
..2	TE10201002	10P CONNECTOR SOCKET	1.000	P301
..2	TE612000301	3P CONNETOR SOCKET	2.000	P2,303
..2	TE612000402	4P CONNECTOR SOCKET	1.000	P107
..2	TE612000702	7P CONNECTOR SOCKET (RED)	1.000	J4A
..2	TE612000901	9P CONNECTOR SOCKET	1.000	P302
..2	TE612001002	10P CONNECTOR SOCKET 180° (RED)	1.000	J106
..2	TE612001602	16P CONNECTOR SOCKET	1.000	P105
..2	TE962541401	14P CONNECTOR SOCKET	1.000	P111
.1	TWPC06A00201	FUNCTION PCB ASS'Y	1.000	
..2	PC06A002	PCB BOARD (FUNCTION)	1.000	
..2	TWPC06A002A01	PAD PCB ASS'Y	1.000	15
...3	CS104K5005X7R	CHIP CAP 0.1UF ±10% 50V 0805	2.000	C401,402
...3	IC4051BFN	IC (TC4051BFN)	2.000	IC401,402
...3	RS47218J05	CHIP RES. 4.7K OHM,1/8W,±5%,0805	2.000	R401,402
...3	AL4-15-3116	HEADER 16-PIN SIL ZIF FMZ	1.000	J1
...3	TE622001002	10P CONNECTOR SOCKET 90° (RED)	1.000	J106
..2	TWPC06A002B01	CF PCB ASS'Y	1.000	36
...3	AA822373X	SOCKET BL112-42RL 42P	1.000	J103
...3	AA822374X	SOCKET CFHD-19-0034 50P	1.000	J104
...3	CS104K5005X7R	CHIP CAP 0.1UF ±10% 50V 0805	2.000	C801,802
...3	AA822406X	CF CARD CONNECTOR EJECTOR	1.000	(J104)
...3	NUT0102IID	N20STL N13	2.000	
...3	SC0206RINI	SCREW	2.000	
..2	TWPC06A002C01	MIDI PCB ASS'Y	1.000	17
...3	AL7-20-0078	INDUCTOR FERRITE BEAD 30 OHM @ 100MHZ 0805	4.000	FL501,502,503,504
...3	CS471J5005COG	CAPACITOR 470PF 5% NPO 50V 0805 (SMD)	4.000	C503,504,505,506
...3	CS473K5005X7R	CAPACITOR (SMD) 47000PF	1.000	C501
...3	RS47018J05	CHIP RES. 47 OHM,1/8W,±5%,0805	2.000	R3,4
...3	AL4-00-0002	JACK DIN 5 PIN MIDI PCB MOUNT 180° W/SHIELD SOCKE	2.000	J501,502
...3	TE612000402	4P CONNECTOR SOCKET	1.000	P107
.1	TWPC06A00301	OPERATION PCB ASS'Y	1.000	
..2	PC06A003	PCB BOARD (OPERATION)	1.000	
..2	TWPC06A003A01	SW PCB ASS'Y	1.000	40
...3	AA415015J	SW TACT SKQEAD	5.000	SW301,302,303,304,308
...3	AA812086J	LED 3MM GREEN (EVERYLIGHT) 264-10GD	1.000	D4
...3	AA812087J	LED 3MM RED (KINGBRIGHT) L-934SRD-G	4.000	D5,6,304,305
...3	AL6-00-0016	ENCODER 24-POSITION 10MM SC12F2420406	1.000	SW2
...3	AL6-02-0033	SWITCH (OPEN/CLOSE)5MM	25.000	SW305,306,307,309,310,311,312,313,314, SW315,316,317,318,319,320,321,322,323, SW324,325,326,327,328,329,330
...3	CS103K5005X7R	C.CAP 0.010UF 50V X7R,±10% SMD 0805	2.000	C203,204
...3	TE622000901	9P CONNECTOR SOCKET	1.000	P302
...3	TE622001001	10P CONNECTOR SOCKET	1.000	P301
..2	TWPC06A003B01	POT PCB ASS'Y	1.000	11
...3	AA812086J	LED 3MM GREEN (EVERYLIGHT) 264-10GD	1.000	D3
...3	AL0-09-0056	VARIABLE RESISTOR SLIDE 10KB	1.000	R1
...3	AL0-09-0058	VR RK14K1230005-10K15AX2 10KA DUAL VERT 15MM	2.000	P1,2
...3	AL6-02-0033	SWITCH (OPEN/CLOSE)5MM	1.000	SW331
...3	CS103K5005X7R	C.CAP 0.010UF 50V X7R,±10% SMD 0805	2.000	C201,202
...3	JW5206T	JUMPER WIRE (A.I.) 52MM	1.000	J3
...3	TE622000302	3P CONNECTOR SOCKET	1.000	P303
...3	TE622000701	7P CONNECTOR SOCKET	1.000	J4B
...3	TE622000702	7P CONNECTOR SOCKET (RED)	1.000	J4A

MPC500 WIRING DIAGRAM

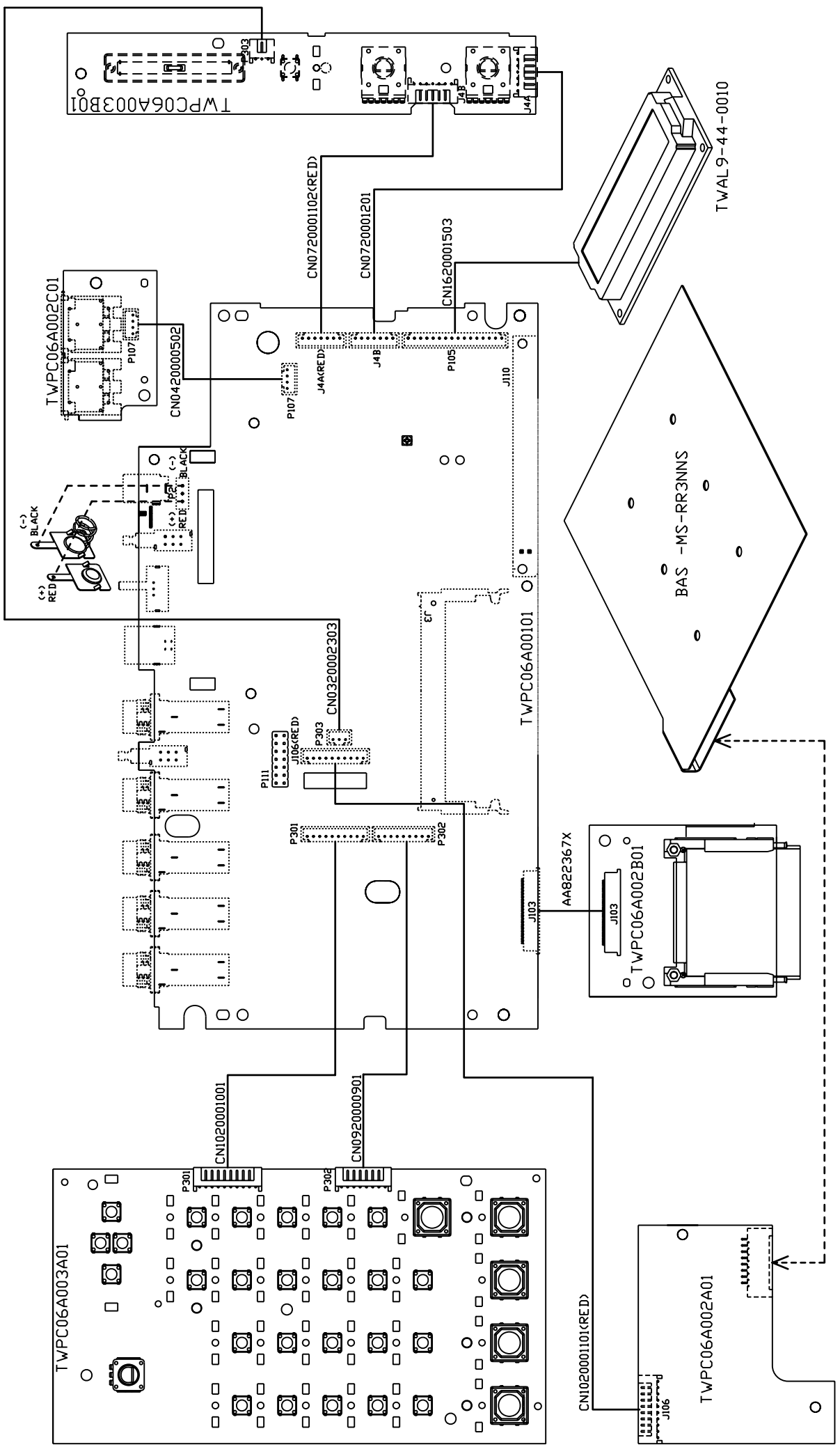

REVISION RECORD			
LTR	ECD NO.	APPROVED:	DATE:

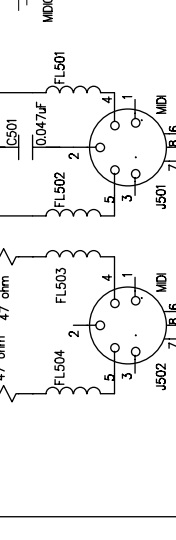
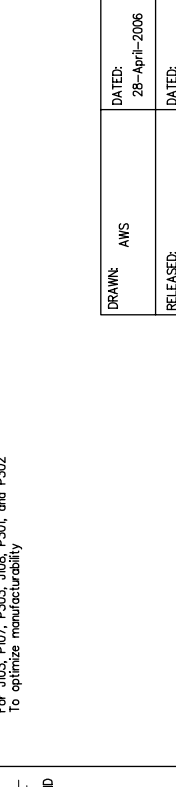
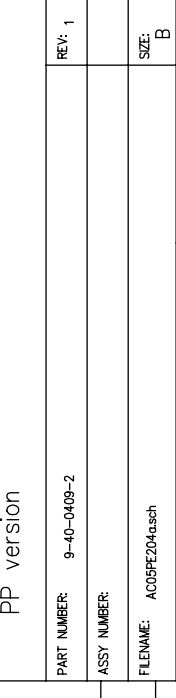
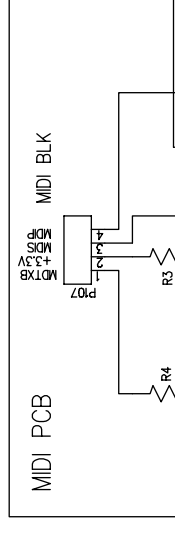
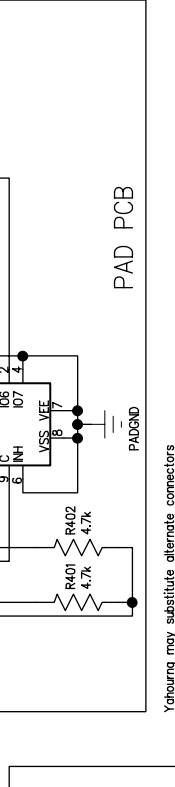
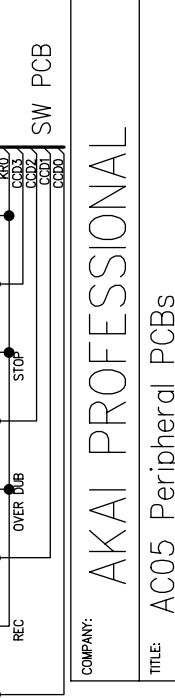
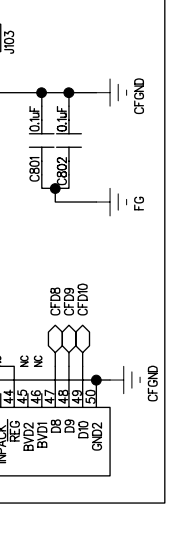
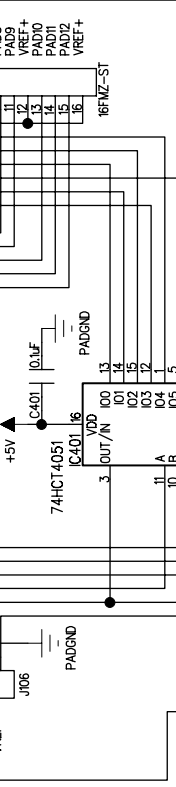
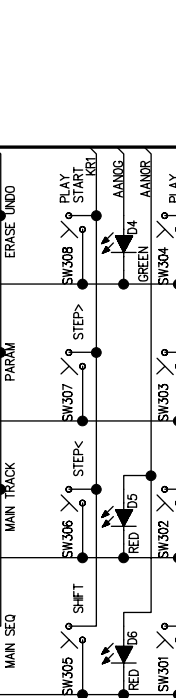
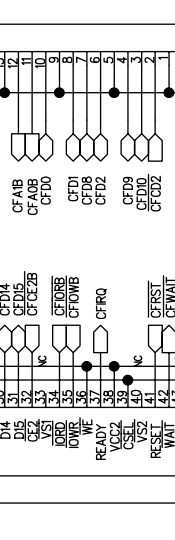
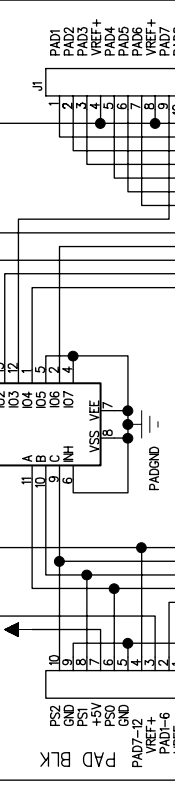
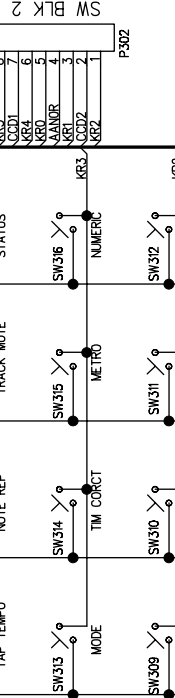
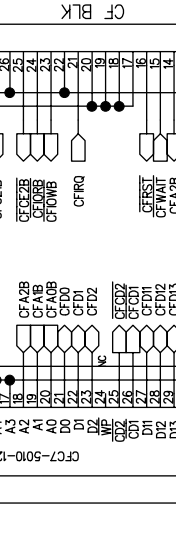
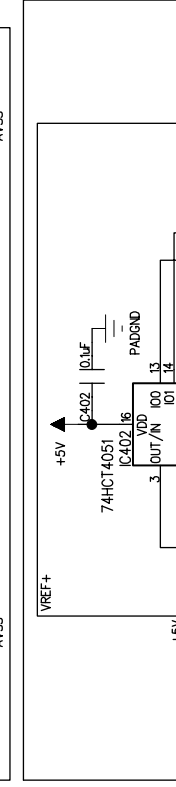
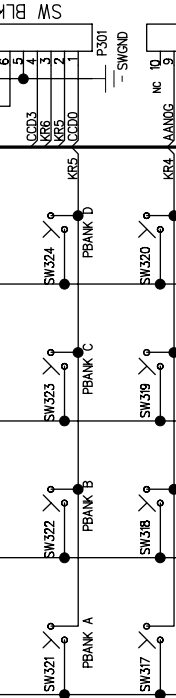
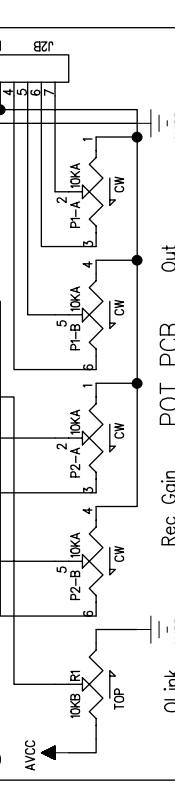
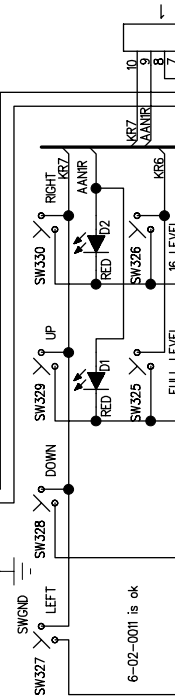
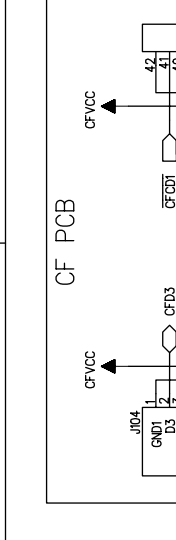
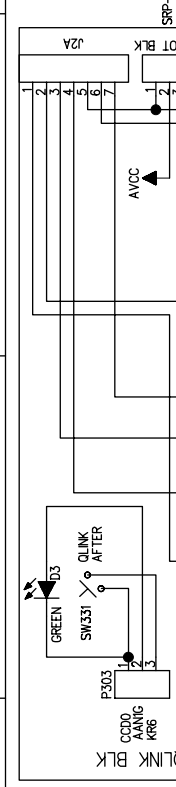

COMPANY:	AKAI PROFESSIONAL
TITLE:	AC05 Peripheral PCBs PP version
PART NUMBER:	9-40-0409-2
ASSY NUMBER:	
FLENAME:	AC09PEZ04asch
SCALE:	
REV: 1	
SIZE:	B
SHEET:	1 OF 1

DRAWN:	AWS
RELEASED:	
DATED:	28-April-2006
DATED:	

Yohjiro may substitute discrete components for ICs P301, P302, P303, P304, P305, and P302 to optimize manufacturability.

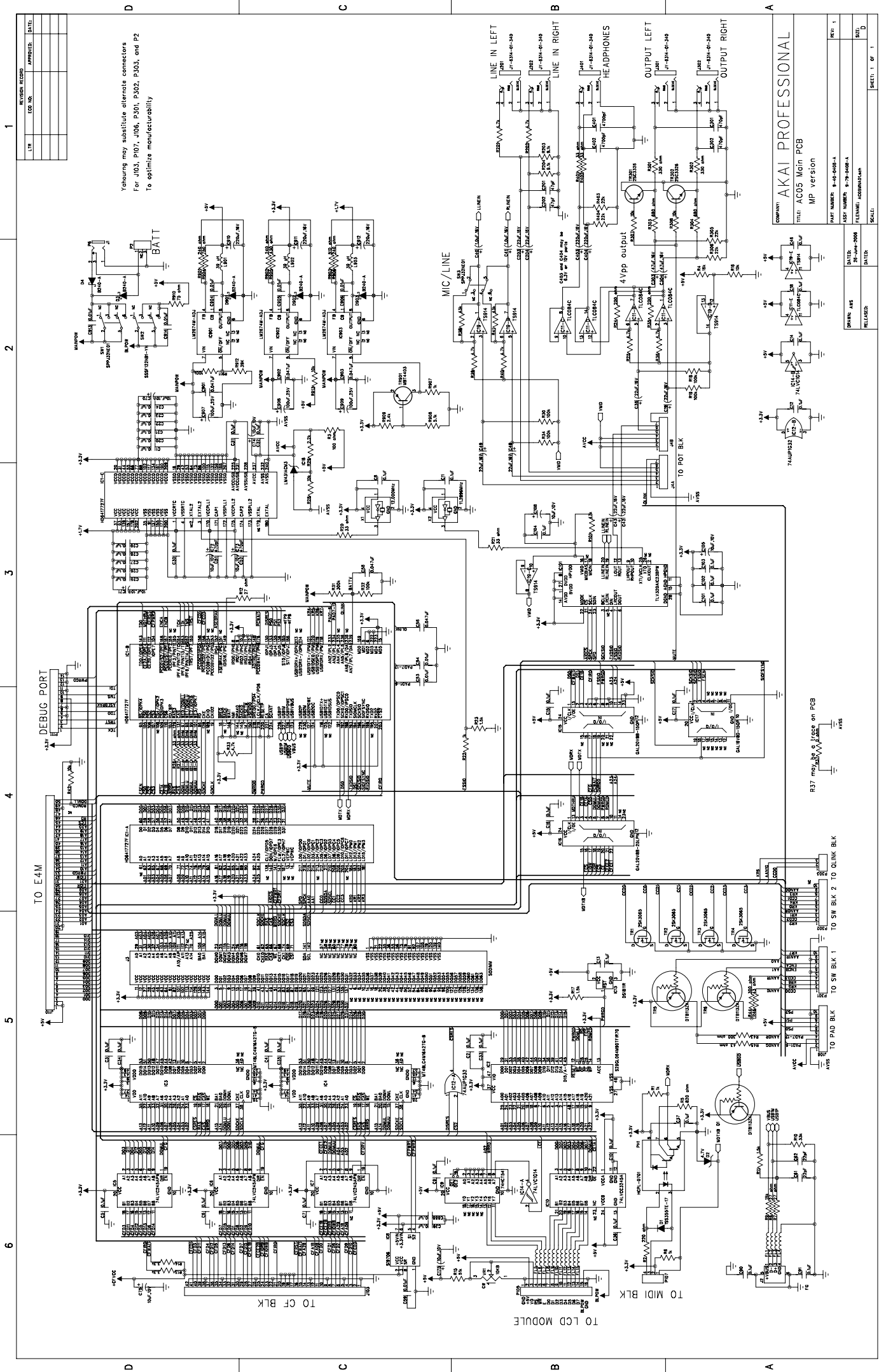

Yabourg may substitute alternate connectors
 For J03, J07, J08, P301, P302, J303, and P2
 To optimize manufacturability

COMPANY: **AKAI PROFESSIONAL**
 TITLE: AC05 Main PCB
 MP version

PART NUMBER: R-00-048-A
 REV: 1

DATE: 20-JUN-2008
 RELEASED: DATE: SCALE: SHEET 1 OF 1

1
 2
 3
 4
 5
 6

D
 C
 B
 A